





# HiKu

## HIGH POWER MONO PERC MODULE



### 360W~385W

CS3L-360 | 365 | 370 | 375 | 380 | 385MS

#### MORE POWER

-  26 % higher power than conventional modules
-  Up to 4.5 % lower LCOE  
Up to 2.7 % lower system cost
-  41°C Low NMOT:  $41 \pm 3$  °C  
Low temperature coefficient (Pmax):  
-0.34 % / °C
-  Better shading tolerance

#### MORE RELIABLE

-  Lower internal current,  
lower hot spot temperature
-  Minimizes micro-crack impacts
-  Heavy snow load up to 5400 Pa,  
wind load up to 3600 Pa\*

\*Black frame product can be provided upon request.

**12 Years** Enhanced Product Warranty on Materials and Workmanship\*

**25 Years** Linear Power Performance Warranty\*

**1<sup>st</sup> year power degradation no more than 2%**  
**Subsequent annual power degradation no more than 0.55%**

\*According to the applicable Canadian Solar Limited Warranty Statement.

#### MANAGEMENT SYSTEM CERTIFICATES\*

ISO 9001:2015 / Quality management system  
ISO 14001:2015 / Standards for environmental management system  
ISO 45001: 2018 / International standards for occupational health & safety

#### PRODUCT CERTIFICATES\*

IEC 61215 / IEC 61730 / CE / MCS / INMETRO / UKCA  
UL 61730 / IEC 61701 / IEC 62716  
UNI 9177 Reaction to Fire: Class 1 / Take-e-way



\* The specific certificates applicable to different module types and markets will vary, and therefore not all of the certifications listed herein will simultaneously apply to the products you order or use. Please contact your local Canadian Solar sales representative to confirm the specific certificates available for your product and applicable in the regions in which the products will be used.

**CSI Solar Co., Ltd.** is committed to providing high quality solar products, solar system solutions and services to customers around the world. Canadian Solar was recognized as the No. 1 module supplier for quality and performance/price ratio in the IHS Module Customer Insight Survey, and is a leading PV project developer and manufacturer of solar modules, with over 55 GW deployed around the world since 2001.

\* For detailed information, please refer to Installation Manual.

## ENGINEERING DRAWING (mm)

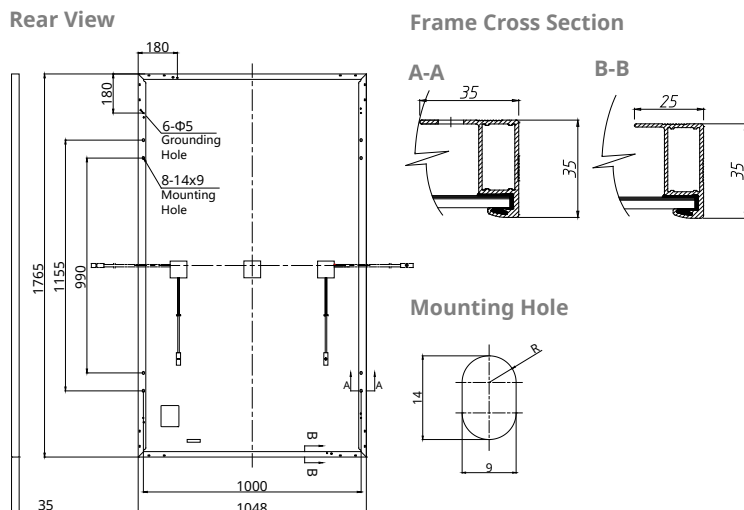

## CS3L-360MS / I-V CURVES

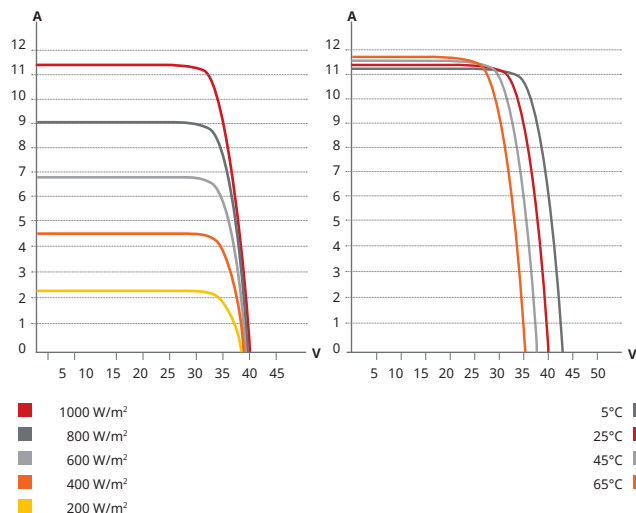

## ELECTRICAL DATA | STC\*

CS3L	360MS	365MS	370MS	375MS	380MS	385MS
Nominal Max. Power (Pmax)	360 W	365 W	370 W	375 W	380 W	385 W
Opt. Operating Voltage (Vmp)	33.7 V	33.9 V	34.1 V	34.3 V	34.5 V	34.7 V
Opt. Operating Current (Imp)	10.69 A	10.78 A	10.86 A	10.94 A	11.02 A	11.10 A
Open Circuit Voltage (Voc)	40.4 V	40.6 V	40.8 V	41.0 V	41.2 V	41.4 V
Short Circuit Current (Isc)	11.40 A	11.47 A	11.54 A	11.61 A	11.68 A	11.75 A
Module Efficiency	19.5%	19.7%	20.0%	20.3%	20.5%	20.8%
Operating Temperature	-40°C ~ +85°C					
Max. System Voltage	1500V (IEC/UL) or 1000V (IEC/UL)					
Module Fire Performance	TYPE 1 (UL 61730 1500V) or TYPE 2 (UL 61730 1000V) or CLASS C (IEC 61730)					
Max. Series Fuse Rating	20 A					
Application Classification	Class A					
Power Tolerance	0 ~ + 10 W					

\* Under Standard Test Conditions (STC) of irradiance of 1000 W/m<sup>2</sup>, spectrum AM 1.5 and cell temperature of 25°C.

## ELECTRICAL DATA | NMOT\*

CS3L	360MS	365MS	370MS	375MS	380MS	385MS
Nominal Max. Power (Pmax)	270 W	274 W	278 W	281 W	285 W	289 W
Opt. Operating Voltage (Vmp)	31.6 V	31.8 V	32.0 V	32.2 V	32.3 V	32.5 V
Opt. Operating Current (Imp)	8.55 A	8.62 A	8.68 A	8.75 A	8.81 A	8.88 A
Open Circuit Voltage (Voc)	38.2 V	38.4 V	38.6 V	38.8 V	38.9 V	39.1 V
Short Circuit Current (Isc)	9.19 A	9.25 A	9.31 A	9.36 A	9.42 A	9.47 A

\* Under Nominal Module Operating Temperature (NMOT), irradiance of 800 W/m<sup>2</sup>, spectrum AM 1.5, ambient temperature 20°C, wind speed 1 m/s.

## MECHANICAL DATA

Specification	Data
Cell Type	Mono-crystalline
Cell Arrangement	120 [2 X (10 X 6) ]
Dimensions	1765 X 1048 X 35 mm (69.5 X 41.3 X 1.38 in)
Weight	20.5 kg (45.2 lbs)
Front Cover	3.2 mm tempered glass
Frame	Anodized aluminium alloy
J-Box	IP68, 3 bypass diodes
Cable	4.0 mm <sup>2</sup> (IEC), 12 AWG (UL)
Cable Length (Including Connector)	Portrait: 500 mm (19.7 in) (+) / 350 mm (13.8 in) (-) (supply additional cable jumper: 2 lines/pallet) ; landscape: 1250 mm (49.2 in)*
Connector	T4 series or MC4-EVO2
Per Pallet	30 pieces
Per Container (40' HQ)	780 pieces

\* For detailed information, please contact your local Canadian Solar sales and technical representatives.

## TEMPERATURE CHARACTERISTICS

Specification	Data
Temperature Coefficient (Pmax)	-0.34 % / °C
Temperature Coefficient (Voc)	-0.26 % / °C
Temperature Coefficient (Isc)	0.05 % / °C
Nominal Module Operating Temperature	41 ± 3°C

## PARTNER SECTION

**Bluefin**  
S O L A R T E C H

Bluefin Century s.r.o. - SLOVAKIA  
Email: sales@bluefin.sk  
Web: www.bluefinsolarshop.com  
Tel: +421 2206 33178

\* The specifications and key features contained in this datasheet may deviate slightly from our actual products due to the on-going innovation and product enhancement. CSI Solar Co., Ltd. reserves the right to make necessary adjustment to the information described herein at any time without further notice. Please be kindly advised that PV modules should be handled and installed by qualified people who have professional skills and please carefully read the safety and installation instructions before using our PV modules.

## CSI Solar Co., Ltd.

199 Lushan Road, SND, Suzhou, Jiangsu, China, 215129, www.csisolar.com, support@csisolar.com